

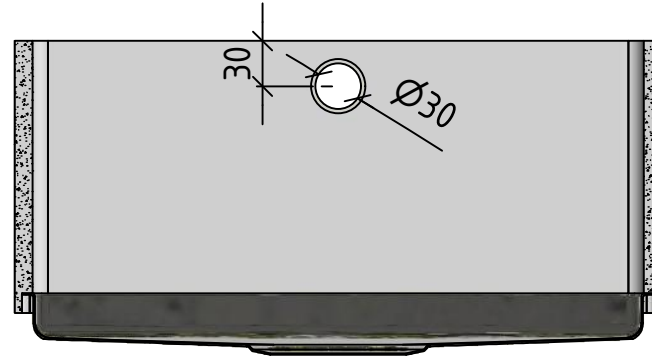

VOIT & PARTNER
Mineralwerkstoff Manufaktur

VSPE 40-40

A-A (1:5)



B-B (1:5)

